

VIDEO CASSETTE PLAYER

HR-P94K/P54A

Thank you for purchasing this JVC video cassette player. To ensure optimum performance of this unit, please read this instruction manual thoroughly.

1 Features

- 3 system (PAL/MESECAM/NTSC)
- NTSC playback (on PAL television)
- RF output G/K switchable
- Digital auto tracking
- HQ (High Quality)
- Auto playback function
- Repeat playback
- Shuttle search
- Still and slow motion
- Line recording
- Karaoke (HR-P94K only)
- B.E.S.T. (Biconditional Equalized Signal Tracking) picture system

2 Automatic features

Auto power on
The video cassette player is automatically turned on when the tape is inserted.

Auto rewind
The video tape is automatically rewound when the end of the tape is reached during the play, recording or shuttle search forward mode.

Auto playback
If the video cassette's safety tab has been removed, playback will begin automatically when the tape is inserted into the video cassette player.

Power off eject
Even when the video cassette player's power is off, pressing the eject button will turn the power on and eject the tape. Once ejected, the power will be turned off again automatically.

Auto head cleaning
When a tape is loaded or ejected the VCP video head is cleaned automatically.



- Only cassettes marked "VHS" can be used with this video cassette player.

LPT0457-001A

5 Wireless remote control

When using the remote control for operation of the video cassette player, make sure that it is pointed at the remote sensor window. You can also use the player's remote control to operate a JVC television.

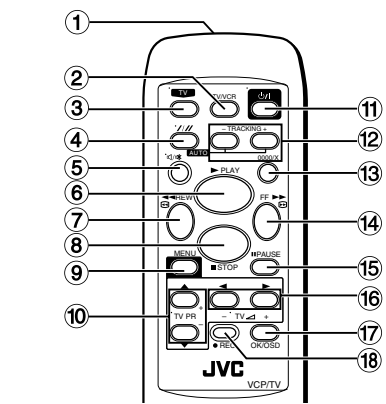

- Transmitting window**
- TV/VCR (Player) button**
To switch JVC TV's mode between TV and VIDEO.
- TV button**
To enable remote control of JVC TV.
- AUTO button**
To enable/disable auto tracking mode.
- SP/LP/EP(///) button**
• To select the recording tape speed.
• To select JVC TV's sounds.
- Muting (TV Muting) button**
• To select output sound mode (HR-P94K only).
• To mute the JVC TV volume.
- ▶ PLAY button**
To start playback.
- REW ◀▶ button**
To rewind the video tape. Also to start reverse shuttle search playback.
- STOP button**
To stop playback.
- MENU button**
To access Mode Set screen.
- ▲/▼ buttons**
To select the mode.
TV PR +/- buttons
To select a preset position.

- STANDBY/ON ⏻/⏻ button**
To turn the power on and off (standby)
- TRACKING +/- buttons**
To adjust tracking during playback.
- 0000/X button**
To reset the tape counter.
- FF ▶▶ button**
To fast forward the video tape. Also to start forward shuttle search playback.
- PAUSE button**
To freeze the picture during playback. Also to engage the recording pause mode.
- ◀▶ buttons**
To set the mode.
TV +/- (TV Volume) buttons
To adjust the TV volume.
- OK/OSD button**
• To fix the setting.
• To display the information on the television's display.
- REC button**
Press the ● REC and ▶ PLAY buttons together, to start recording.

Operating JVC TVs
Buttons with a small dot on the left side of the name can also be used to operate your JVC TV while holding down TV.
To operate your TV, while holding down TV, press the corresponding button: ⏻/⏻, TV/VCR, TV PR +/-, TV +/- (TV Volume), Muting (TV Muting), /// (TV Sounds).

- Notes:**
- Point the remote control toward the remote sensor window.
 - The maximum operating distance of the remote control is about 8 m.
 - When inserting the batteries, be sure to insert in the correct directions as indicated under the battery cover.
 - If the remote control doesn't work properly, remove its batteries, wait a short time, replace the batteries and then try again.

3 Precautions

The rating plate and the safety caution are on the rear of the unit.

WARNING: DANGEROUS VOLTAGE IN-SIDE
WARNING: TO PREVENT FIRE OR SHOCK HAZARD, DO NOT EXPOSE THIS UNIT TO RAIN OR MOISTURE.

The STANDBY/ON ⏻/⏻ button does not completely shut off mains power from the unit, but switches operating current on and off.

This unit is produced to comply with Standard IEC 60065.

When the equipment is installed in a cabinet or a shelf, make sure that it has sufficient space on all sides to allow for ventilation (10 cm or more on both side, on top and at the rear.)

When discarding batteries, environmental problems must be considered and the local rules or laws governing the disposal of these batteries must be followed strictly.

Failure to heed the following precautions may result in damage to the player, remote control or video cassette player.

- DO NOT place the player . . .**
... in an environment prone to extreme temperatures or humidity.
... in direct sunlight.
... in a dusty environment.
... in an environment where strong magnetic fields are generated.
... on a surface that is unstable or subject to vibration.
- DO NOT block the player's ventilation openings or holes.**
(If the ventilation openings or holes are blocked by a newspaper or cloth, etc., the heat may not be able to get out.)
- DO NOT place heavy objects on the player or remote control.**
- DO NOT place anything which might spill on top of the player or remote control.**
If water or liquid is allowed to enter this equipment, fire or electric shock may be caused.)
- DO NOT expose the apparatus to dripping or splashing.**
- DO NOT use this equipment in a bathroom or places with water. Also DO NOT place any containers filled with water or liquids (such as cosmetics or medicines, flower vases, potted plants, cups, etc.) on top of this unit.**
- DO NOT place any naked flame sources, such as lighted candles, on the apparatus.**
- AVOID violent shocks to the player during transport.**

Beware of moisture condensation
Moisture in the air will condense on the VCP when you move it from a cold place to a warm place, or under extremely humid conditions — just as water droplets form on the surface of a glass filled with cold liquid. Moisture condensation on the head drum will cause damage to the tape. In conditions where condensation may occur, keep the VCP's power turned on for a few hours to let the moisture dry.

- When transporting**
- Be sure to remove cassette from VCP before packing.
 - Avoid violent shocks to the VCP during packing and transport.

6 On screen display

When "O.S.D" is set to "ON" (⏻ See "9 Mode set"), various operational indicators appear on the TV screen.

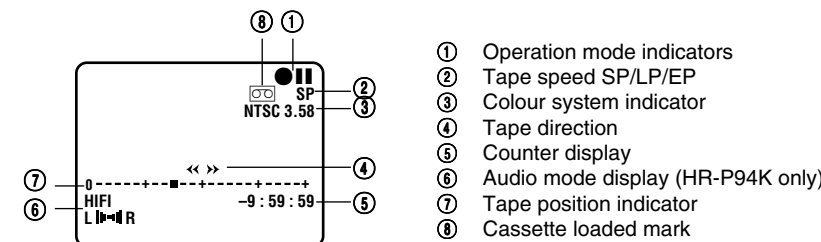

- Operation mode indicators
- Tape speed SP/LP/EP
- Colour system indicator
- Tape direction
- Counter display
- Audio mode display (HR-P94K only)
- Tape position indicator
- Cassette loaded mark

7 Connections

Make sure that the power to the video cassette player and TV is off before making the following connections.

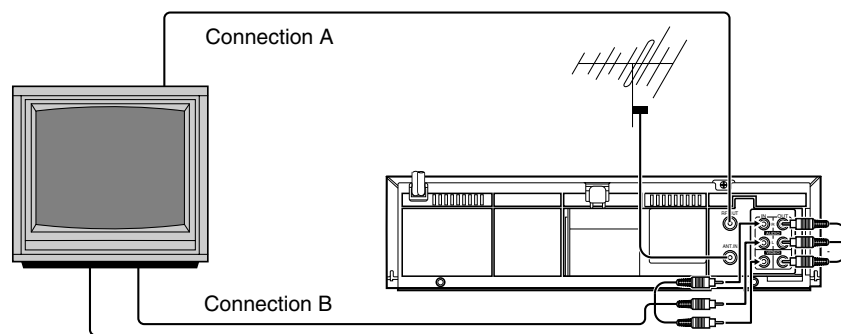

Note:
If you put a TV set directly on this Video cassette player or install it too close to a TV set, noise may occur. If this noise occurs, separate the Video cassette player and the TV set.

4 Controls

Front panel

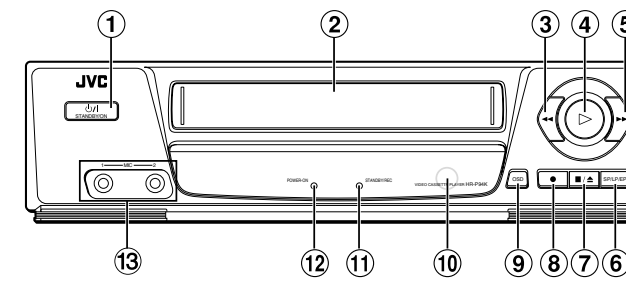

HR-P94K

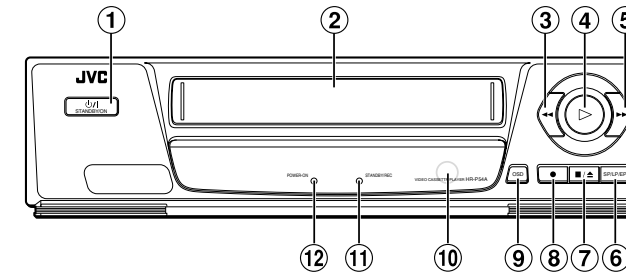

HR-P54A

Rear panel

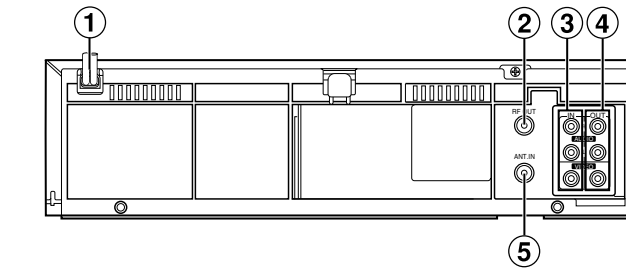

HR-P94K

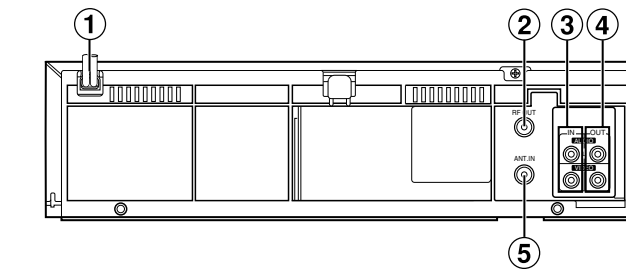

HR-P54A

Connection A (basic)

In order to use the video cassette player it must be connected between the antenna and the TV.

- Connect your TV antenna cable to the video cassette player's ANT. IN terminal.
- Connect one end of the provided RF antenna cable to the video cassette player's RF. OUT terminal and the other end to the TV's antenna terminal.
- Connect the power cord to your household AC outlet.

Connection B

For connection of a TV that has VIDEO/AUDIO IN/OUT terminals. This connection is necessary to record TV programmes. Use RCA type pin connection cords (available from audio/video stores) for connection. This connection is in addition to connection A.

- Follow steps 1 and 2 of "Connection A".
- Connect the TV's VIDEO OUT and AUDIO OUT terminals to the video cassette player's VIDEO IN and AUDIO IN terminals.
- Connect the TV's VIDEO IN and AUDIO IN terminals to the VCP's VIDEO OUT and AUDIO OUT terminals.
- Connect the power cord to your household AC outlet.

Front panel

- STANDBY/ON ⏻/⏻ button**
To turn the power on and off (standby mode).
- Cassette loading slot**
Load the video cassette here.
- Rewind ◀▶ button**
To rewind the video tape and to start reverse shuttle search playback mode.
- Play ▶ button**
To start playback.
- Fast forward ▶▶ button**
To fast forward the video tape and to start forward shuttle search playback mode.
- SP / LP / EP button**
To select the recording tape speed.
- Stop/Eject ■/▲ button**
To stop playback and to eject the video tape.
- Record ● button**
To start recording.
- OSD button**
To display the information on the television's display.
- Remote sensor window**
For remote control operation.
- STANDBY / REC indicator**
• Lights when the power turns off (Standby mode) or during recording mode.
• Blinks during recording pause mode.
- POWER-ON indicator**
Lights when the power turns on.
- MIC input terminals (HR-P94K only)**

Rear panel

- AC power cord
- RF. OUT terminal
- AUDIO/VIDEO IN terminals
- AUDIO/VIDEO OUT terminals
- ANT. IN terminal

* The video cassette player illustrations appearing in this instruction manual are of the HR-P94K.

8 Setting the video channel

To watch videos on your TV, it must be set to the same UHF channel as the video cassette player. This channel is used as the video channel. This video cassette player has been preset to UHF channel 36.

- Note:**
- When you have connected the VIDEO/AUDIO OUT terminals of this video cassette player to your TV's video/audio in terminals (connection B of the "Connections" section), setting the video channel is not necessary. In this case simply set the TV's TV/VCR switch to VCR.

IMPORTANT:
Before performing the following steps, make sure the player's power is off and there is no cassette inserted in the player.

- Access video channel set mode.**
Hold down ■/▲ on the video cassette player until the both of POWER-ON and STANDBY/REC indicators light.

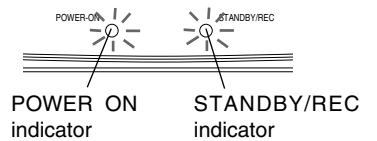

- Set video channels.**
Set your TV to UHF channel 36.
• If the two vertical white bars appear clearly on the screen as shown in the illustration on the right, press OK and then go to step 3.
• If the two vertical white bars do not appear clearly, press TRACKING + or - to set the video cassette player to a vacant channel between 32 and 40 which is not occupied by any local station in your area.
• The mode indicators tell channel position. The indicators blink different speed by the channel position as shown on the right.

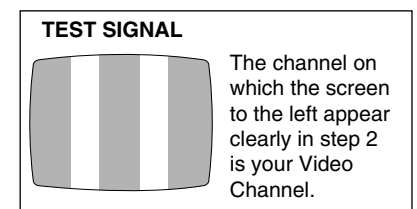

To view picture signals from the video player, set your TV to the Video Channel.

- Press OK.**
• STANDBY/REC indicator goes off.
- Set TV system.**
Set "RF OUT" to "B/G" or "D/K". (⏻ See "9 Mode set")

CH	POWER-ON (green)	STANDBY/REC (red)	Blinking Speed
40	—	blink	fast
39	—	blink	↑
38	—	blink	↑
37	—	blink	slow
36	light	light	—
35	blink	—	slow
34	blink	—	↓
33	blink	—	↓
32	blink	—	fast

9 Mode set

You can change various mode setting on the Mode Set screen by following procedure described below.

- Access the Mode Set screen.**
Press MENU.
- Select the mode.**
Press ▲/▼ to move the pointer to the item you want to change.
- Select the mode setting.**
Press ◀/▶.
- Return to the normal screen.**
Press MENU.

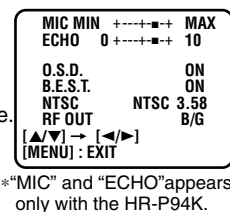

*"MIC" and "ECHO" appears only with the HR-P94K.

*The default setting is bold in the table below.

■MIC (HR-P94K only)	See "Karaoke features" below.
■ECHO (HR-P94K only)	See "Karaoke features" below.
■O.S.D. ON OFF	When the function is set to "ON", various operational indicators appear on the TV screen. NOTE: When you use this video cassette player as the source player for editing, be sure to set "O.S.D." to "OFF" before starting.
■B.E.S.T. ON OFF	You can set the B.E.S.T. (Biconditional Equalized Signal Tracking) system to "ON" or "OFF".
■NTSC NTSC3.58: Select this mode to watch NTSC tapes on a NTSC system TV. NTSC4.43: Select this mode to watch NTSC tapes on a multi-system TV. (that has an NTSC4.43 setting) Select NTSC4.43 to record 4.43 signal. NTSC→PAL: Select this mode to watch NTSC tapes on a PAL system TV.	To watch an NTSC tape, it will be necessary to select one of the output mode. NOTES: NTSC Playback on PAL TV • The vertical size of the playback picture will shrink and some picture "noise" may appear on the screen. • The playback picture may roll. In this case adjust the picture with the TV's vertical hold knob (with some TV's this adjustment may not be possible). • The colour of the playback picture may differ from the original. • In the forward/reverse shuttle search or still modes there may be no colour depending on the TV and video cassette player combination.
■RFOUT B/G: New Zealand, Kuwait, U.A.E., Indonesia, Singapore, Thailand, Malaysia, Iran, Saudi Arabia D/K: Egypt, Morocco, Lebanon, Iraq, China, Mongolia, Russia	Set appropriate TV system that matches the system of TV being used.

12 Karaoke features

Karaoke (HR-P94K only)

Use this feature to enjoy karaoke video. Connect a microphone to both MIC 1 and MIC 2 for duets.

- Insert a pre-recorded Karaoke tape.**

- Press ▶.**

- **Karaoke search**
You can search the desired tune by pressing ◀/▶.
The Karaoke search can be operated only when the mute section is more than 4 seconds between tune and tune.

- Adjust the MIC or ECHO volume as necessary.**
Press MENU to access the Mode Set screen then press ▲/▼ to select MIC or ECHO.
Press ◀/▶ to adjust the MIC or ECHO volume.
Press MENU to return normal screen.

- Start singing.**

Note:
Check that the power is off (standby mode) before plugging in the microphone.

- **Soundtrack Selection (HR-P94K only)**
During Playback
Pressing ◀/▶ changes the soundtrack being played back as follows:

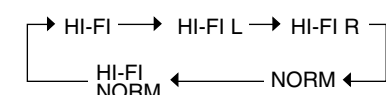

10 Playback

NTSC, PAL and MESECAM video tapes can be played back on this video cassette player. Refer to the "Mode Set" section for details.

Before proceeding:

- Turn on the power of the TV and video cassette player.
- Make sure that the TV is set to the video channel or that the TV's TV/VIDEO switch is set to VIDEO (refer to the "Setting the video channel" section for details).

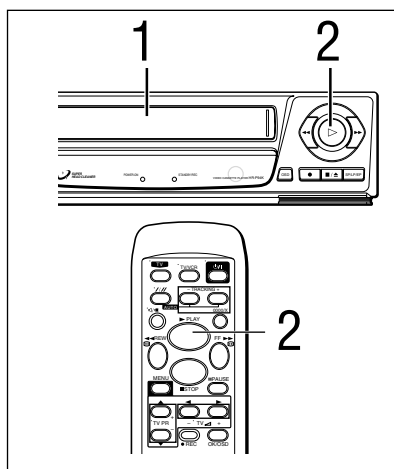

- Load a pre-recorded cassette.**
If the safety tab on the cassette is removed, playback will start automatically.
- Press ▶ to start playback.**
"B.E.S.T. PICTURESYSTEM" appears on the screen. (When B.E.S.T. is set to "ON". [F] "9 Mode set")

- **Press ■/▲ or the remote control's ■ to stop playback. Then press ■/▲ to remove the cassette.**

To fast forward or rewind the tape:
■ **From the stop mode, press ▶▶ or ◀◀.**

Slow motion playback

Slow motion playback is 1/6 of the normal playback speed. The sound will be cut during slow motion playback.

During playback:

- Press ■ for 2 seconds.**

- **Press ▶ to return to the normal playback speed.**

Notes:

- If the picture shakes during the slow mode, use TRACKING +/- to correct the picture.
- After approx. 5 minutes, the slow mode will disengage to protect the video tape.

Still picture and frame advance

Use this feature to freeze the playback picture and to advance one frame at a time. The sound will be cut during this mode.

During playback:

- Press ■.**
The picture will be frozen.

- Press ■ repeatedly to advance frames.**
Each time the button is pressed the still picture will advance one frame.

- **Press ▶ to resume normal playback.**

Notes:

- If the picture shakes during the still mode, use TRACKING +/- to correct the picture.
- After the picture has been frozen for approx. 5 minutes, the still mode will disengage to protect the video tape.

14 Editing

Editing To/From Another Recorder

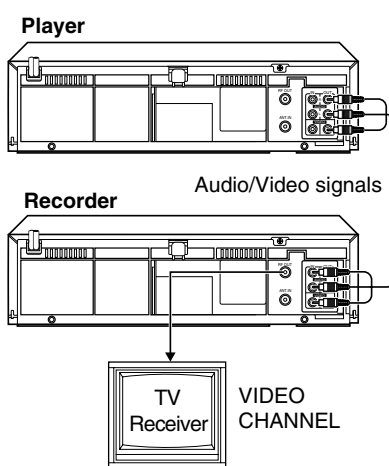

- Connect the player's AUDIO and VIDEO OUT connectors to the recorder's AUDIO and VIDEO IN connectors.**

- Put the player in the Play mode.**

- Put the recorder in the Record mode.**

Notes:

- NTSC tapes being played back in the NTSC PLAYBACK ON PAL TV mode cannot be dubbed to another recorder.
- When you dub an NTSC tape using your recorder as the playback deck, select NTSC 3.58 (or 4.43) with the Colour System Output switch.

Important:

- To edit, both the player and the recorder must be of the same colour system. Set "NTSC" to appropriate mode. ([F] See "9 Mode set")

Shuttle search playback

Use this feature during playback to visually locate any point on a recorded cassette. The sound will be cut during shuttle search operation.

During playback:

- Press ▶▶ or ◀◀ to engage shuttle search forward or reverse.**

- **Press ▶ to resume normal playback.**

Note:

For short searches, press and hold ▶▶ or ◀◀. When released, normal playback will continue.

Tracking adjustment

Automatic tracking is adjusted each time a cassette is inserted in the video cassette player, you may wish to adjust tracking manually during playback.

Manual tracking:

- Press the remote control's AUTO.**
 - Press the remote control's TRACKING + or - to adjust tracking.**
- **Press AUTO to return to automatic tracking.**

Counter reset

- Press OSD to show counter display on the screen.**
- Press 0000 to reset the counter.**

Repeat playback

Use this feature to repeat playback of a cassette 100 times.

During playback:

- Press ▶ for more than 5 seconds.**
The Play indicator will blink slowly and playback of the cassette will repeat 100 times automatically.

- Press ■ to stop repeat playback.**
Tape playback will be stopped and the repeat playback mode will be cancelled.

Note:

Pressing ▶, ◀▶▶ or ■ also stops Repeat playback.

Rewind playback or power off

When the tape has finished rewinding, the Video cassette player will play back or turn itself off.

During stop:

- For Automatic Start Of Playback
Press ◀◀, then press ▶ within 2 seconds.
- For Automatic Power Off
Press ◀◀, then press ⏻ within 2 seconds.

ATTENTION:

In the search, still, slow-motion or frame advance mode,
• the picture will be distorted.
• the noise bars will appear.
• there will be loss of colour.
• the picture may not appear.
However, this is not malfunction. These problems may occur especially with HR-P54A.

11 Recording

Use the following procedure to record TV programmes on a blank video tape.

Before proceeding:

- To record TV programmes, the video cassette player must be connected to the TV as shown in connection B of the "Connections" section.
- Turn on the power of the TV and video cassette player.
- Make sure that the video cassette's safety tab is intact. If it has been removed, cover the hole with adhesive tape.

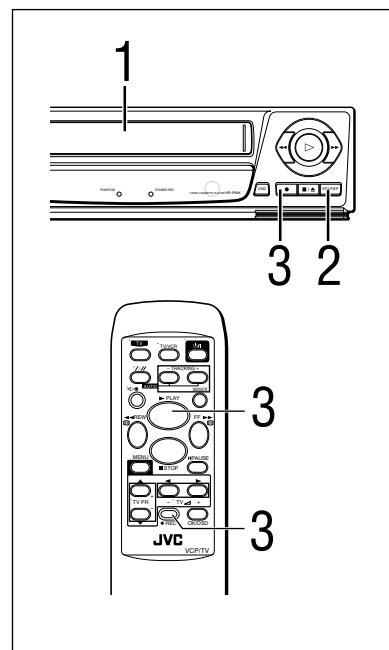

- Load a blank video tape.**
- Press SP/LP/EP(///) to set the recording speed.**
- Press ● to start recording. (On the remote control unit press ● and ▶ at the same time.)**
The recording indicator will light during recording.

B.E.S.T. takes place at the beginning of each first SP and first LP (or EP) recording after inserting the cassette.

- **Press ■/▲ or the remote control's ■ to stop recording.**

To stop recording temporarily:

- **Press II.**
The recording indicator will blink. Press ▶ to resume recording.

Notes:

- To engage recording standby, press ● and then press II. The STANDBY/REC indicator will blink during recording standby. Press ▶ again to start recording.
- If ● does not work, check to see if the cassette safety tab has been removed.
- The player automatically stops when record-standby continues for more than 5 minutes.
- The video tape will be rewound automatically when the end of the tape is reached.

16 Specifications

Format	VHS Standard
Video recording system	Rotary, slant azimuth helical scan system
Rotary heads	[HR-P94K] 4 video heads [HR-P54A] 2 video heads
RF output	System B/G, D/K type modulation UHF ch 32 - 40 adjustable (preset ch 36)
Recording (line input)	PAL, SECAM (MESECAM tape) NTSC 3.58, NTSC 4.43
Playback (line output)	PAL, SECAM (MESECAM tape) NTSC 3.58 NTSC 4.43 Simulated PAL (NTSC tape)
Video	
Line input level	0.5 - 2.0 Vp-p/75 ohms, unbalanced
Line output level	1.0 Vp-p/75 ohms, unbalanced
S/N ratio	More than 45 dB
Horizontal resolution	More than 250 lines (PAL/MESECAM) More than 220 lines (NTSC)
Audio	
Line input level	-8 dBs/50 k ohms, unbalanced
Line output level	-8 dBs/1 k ohm, unbalanced
Frequency response	70 Hz to 10,000 Hz (Normal) [HR-P94K] 20 Hz to 20,000 Hz (Hi-Fi audio)
Power requirements	
Rating	AC 110 V - 240 V, 50 Hz/60 Hz
Operating	AC 90 V - 260 V, 50 Hz/60 Hz
Power consumption	[HR-P94K] 14 W [HR-P54A] 13 W
Operation temperature	5°C to 40°C
Dimensions	360 mm (W) × 94 mm (H) × 279 mm (D)
Weight	3.2 kg

Standard accessories

- Remote control unit
- Batteries for remote control
- RF antenna cable
- Microphone (HR-P94K only)

- Design and specifications subject to change without notice.